

# Compilation (#6) : Intermediate Representations: CFG, Local optimisations

Laure Gonnord & Matthieu Moy & Gabriel Radanne & other  
<https://compil-lyon.gitlabpages.inria.fr/>

Master 1, ENS de Lyon et Dpt Info, Lyon1

2024-2025



## Big Picture

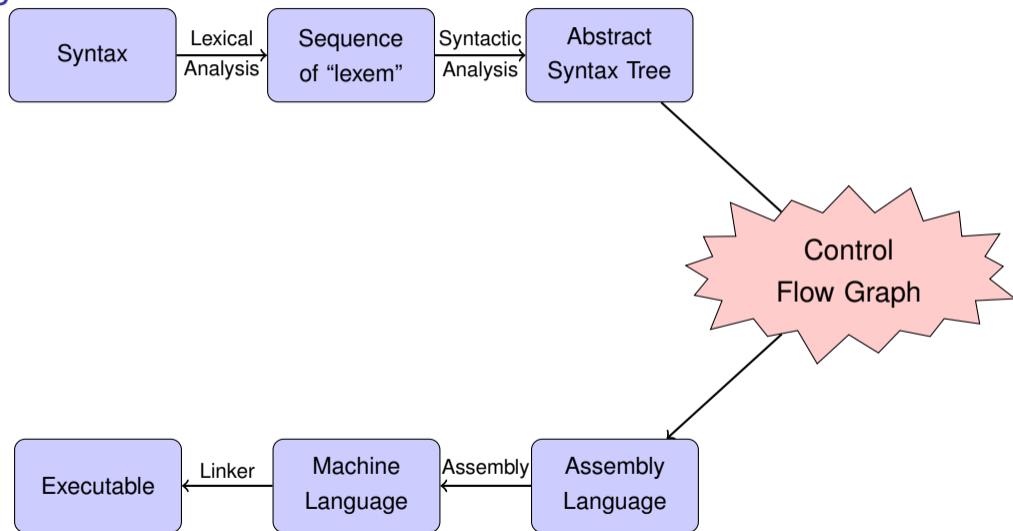

## 3 address construction “problems”

### Temporary reuse ?

```
li temp3, 4
mv temp0, temp3
;; temp3 is never used again
li temp4, 0
mv temp1, temp4
```

temp3 and temp4 could be mapped to the same physical location.

```
li temp5, 4
bge ..., else
    ;; temp5 not used. Its physical
    location can be shared.
j end
else:
    mv temp6, temp5
end
```

► **straight-line code** is difficult to reason on.

# A first IR

Need a better data structure to propagate and infer information. We need:

- Reason about the flow of the program.
- Embeds our three address code.
- ▶ Control-Flow Graph.

- 1 Control flow Graph
- 2 Local optimizations
- 3 Global optimizations

# Definitions

## Definition (BB=Basic Block)

*Basic block: largest (3-address RISC-V) instruction sequence without label. (except at the first instruction) and without jumps and calls.*

## Definition (CFG=Control Flow Graph)

*It is a directed graph whose vertices are basic blocks, and edge  $B_1 \rightarrow B_2$  exists if  $B_2$  can follow immediately  $B_1$  in an execution.*

- ▶ two optimisation levels: local (BB) and global (CFG)

## An example 1/2

Let us consider the program:

```
int x,y;  
if (x<4)  
    y=7;  
else  
    y=42;  
x=10;
```

We already generated the (linear code) for a large part of it.

## An example 2/2

```
li temp3, 4
li temp2, 0
bge temp0, temp3, lbl0
li temp2, 1
lbl0: # if false, jump (skip the 'then')
bge temp2, 0, lelse1
li temp4, 7
mv temp1, temp4 # y gets 7
jump lendif1
lelse1:
li temp4 42
mv temp1, temp4 # y gets 42
lendif1:
li temp5, 10
mv temp0, temp5 # end
```



## An example 2/2

```

li temp3, 4
li temp2, 0
bge temp0, temp3, lbl0
li temp2, 1
lbl0: # if false, jump (skip the 'then')
bge temp2, 0, lelse1
li temp4, 7
mv temp1, temp4 # y gets 7
jump lendif1
lelse1:
li temp4 42
mv temp1, temp4 # y gets 42
lendif1:
li temp5, 10
mv temp0, temp5 # end

```

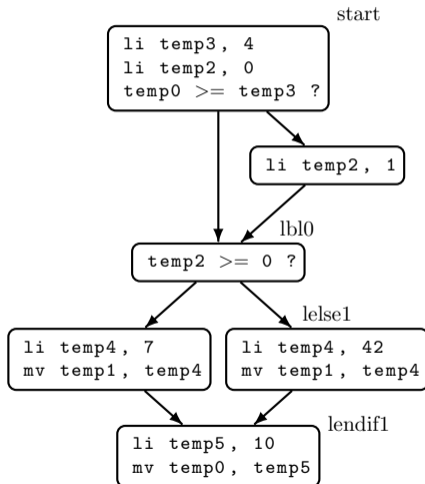

## Identifying Basic Blocks (from 3 address code)

- The first instruction of a basic block is called a **leader**.
- We can identify leaders via these three properties:
  - 1 The first instruction in the intermediate code is a leader.
  - 2 Any instruction that is the target of a conditional or unconditional jump is a leader.
  - 3 Any instruction that immediately follows a conditional or unconditional jump is a leader.
- Once we have found the leaders, it is straightforward to find the basic blocks: for each leader, its basic block consists of the leader itself, plus all the instructions until the next leader.

## Exercise: CFG by hand

```

li temp3, 4
li temp2, 0
bge temp0, temp3, lbl0
li temp2, 1
lbl0: # if false, jump (skip the 'then')
bge temp2, 0, lelse1
li temp4, 7
mv temp1, temp4 # y gets 7
jump lendif1
lelse1:
li temp4 42
mv temp1, temp4 # y gets 42
lendif1:
li temp5, 10
mv temp0, temp5 # end

```

- Identify the Leaders using the three properties
  - 1 The first instruction is a leader.
  - 2 Any instruction that is the target of a conditional or unconditional jump is a leader.
  - 3 Any instruction that immediately follows a conditional or unconditional jump is a leader.
- Identify the Blocks
- Draw the Transitions

- 1 Control flow Graph
- 2 Local optimizations
  - Basic Blocks DAG Construction
  - Instruction Selection
  - Instruction Scheduling
- 3 Global optimizations

## Big picture (Basic Block Optimisation)

- Front-end → a CFG where nodes are basic blocks.
- Basic blocks → DAGs that explicit common computations

```

u1 := c - d
u2 := b + u1
u3 := a * u2
u4 := u2 * u1
u5 := u3 + u4
  
```

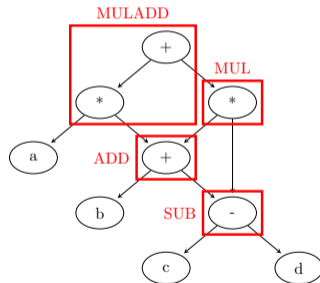

- Choose instructions (**selection**) and order them (**scheduling**).

- ## 2 Local optimizations
- Basic Blocks DAG Construction
  - Instruction Selection
  - Instruction Scheduling

# An Example of BB DAG construction

```
a = b + c
b = a - d
c = b + c
d = a - d
```

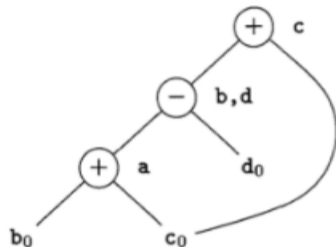

Useful links : <https://www.youtube.com/watch?v=PXTKWvyQUwE> and

<https://www.cse.iitm.ac.in/~krishna/cs3300/pm-lecture3.pdf> for other BB optimisations.

## 2 Local optimizations

- Basic Blocks DAG Construction
- **Instruction Selection**
- Instruction Scheduling



# Instruction Selection, in general

The problem:

- a list of instructions/operations that compute one or more expressions.
- map these operations in “real machine instructions”.
- at minimum cost.

# Instruction Selection

The problem of selecting instructions is a DAG-partitioning problem. But what is the objective ?

## The best instructions:

- cover bigger parts of computation.
  - cause few memory accesses.
- ▶ Assign a cost to each instruction, depending on their addressing mode.

# Instruction Selection: an example

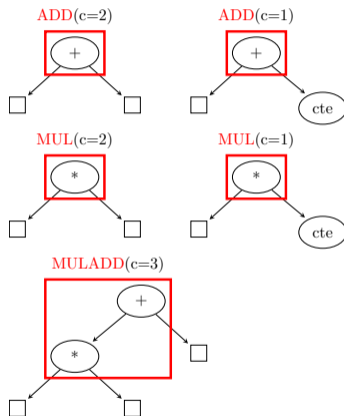

(In RiscV, mulladd is fmaddd (fuse multiply add) and “add with constants” is addi).

What is the optimal instruction selection for:

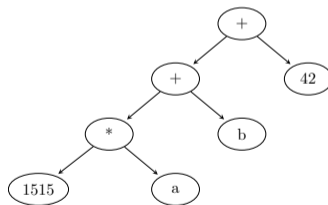

- Finding a tiling of minimal cost: it is **NP-complete** (SAT reduction).

# Tiling trees / DAGs, in practice

For tiling:

- There is an optimal algorithm for **trees** based on dynamic programming.
- For DAGs we use heuristics (decomposition into a forest of trees, ...)
- ▶ The literature is plethoraic on the subject.

# Instruction Selection, in our compiler

Mapping one to one. We don't use `fmadd`.

## 2 Local optimizations

- Basic Blocks DAG Construction
- Instruction Selection
- **Instruction Scheduling**

# Instruction Scheduling, in general

The problem:

- change the order of instructions.
- to “optimise”.
- without “cutting dependencies”.

## Instruction Scheduling, what for?

We want an evaluation order for the instructions that we choose with **Instruction Scheduling**.

A scheduling is a function  $\theta$  that associates a **logical date** to each instruction. To be correct, it must respect data dependencies:

(S1)  $u1 := c - d$

(S2)  $u2 := b + u1$

implies  $\theta(S_1) < \theta(S_2)$ . We can choose  $\theta(S_1) = 0, \theta(S_2) = 1$

► How to choose among many correct schedulings? depends on the target architecture.



## Architecture-dependant choices

The idea is to exploit the different ressources of the machine at their best:

- instruction parallelism: some machines have parallel units (subinstructions of a given instruction).
- prefetch: some machines have non-blocking load/stores, we can run some instructions between a load and its use (hide latency!)
- pipeline.
- registers: see next slide.

(sometimes these criteria are incompatible)

# Register use

Some schedules induce less **register pressure**:

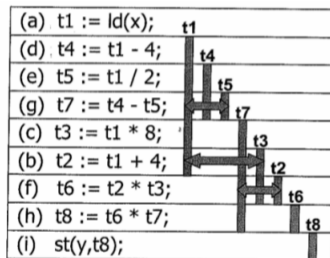
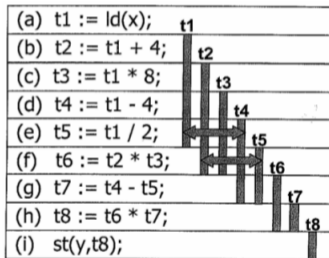

In this picture the dates of the instructions are implicit : line 1 is date 1, line 2 is date 2...

► How to find a schedule with less register pressure?

## Scheduling wrt register pressure

Result: this is a linear problem on trees, but NP-complete on DAGs (Sethi, 1975).

► Sethi-Ullman algorithm on trees, heuristics on DAGs

A slight variation of this algorithm can be found on Wikipedia, the leaves values here are chosen equal to 1 since our machine does not have any direct access to constant values.

## Sethi-Ullman algorithm on trees

$\rho(\text{node})$  denoting the number of (pseudo)-registers necessary to compute a node:

- $\rho(\text{leaf}) = 1$

- $$\rho(\text{nodeop}(e_1, e_2)) = \begin{cases} \max\{\rho(e_1), \rho(e_2)\} & \text{if } \rho(e_1) \neq \rho(e_2) \\ \rho(e_1) + 1 & \text{else} \end{cases}$$

(the idea for non “balanced” subtrees is to execute the one with the biggest  $\rho$  first, then the other branch, then the op. If the tree is balanced, then we need an extra register)

► then the code is produced with postfix tree traversal, the biggest register consumers first.

# Sethi-Ullman algorithm on trees - an example

Min number of (additional) registers  
for  $b^2 + 4ac$  with  $a, b, c$  already in  
registers ?

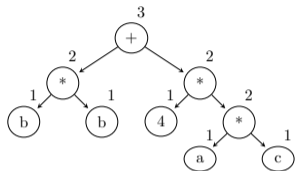

The tree traversal then produces the following code:

	<i>tmp1</i>	<i>tmp2</i>	<i>tmp3</i>	<i>tmp4</i>
mul <i>tmp1</i> , <i>b</i> , <i>b</i>				
mul <i>tmp2</i> , <i>a</i> , <i>c</i>	■			
li <i>tmp3</i> , 4	■	■		
mul <i>tmp4</i> , <i>tmp2</i> , <i>tmp3</i>	■	■	■	
add <i>tmp5</i> , <i>tmp1</i> , <i>tmp4</i>	■			■

cells in black denote for each instruction the set of entry alive temporaries.

## Conclusion (instruction selection/scheduling)

Plenty of other algorithms in the literature:

- Scheduling DAGs with heuristics, . . .
- Scheduling loops (M2IF course on advanced compilation)

Practical session:

- we have (nearly) no choice for the instructions in the RISC-V ISA.
- evaluating the impact of scheduling is a bit hard.

We won't implement any of the previous algorithms.

- 1 Control flow Graph
- 2 Local optimizations
- 3 Global optimizations
  - Introduction to register allocation
  - Analysis for optimizations : Liveness

# Global optimizations

So far, we have taken advantage of basic blocks to make local optimizations, where we do not need to take care of control flow.

This is not sufficient for all optimizations !



# Global optimizations

So far, we have taken advantage of basic blocks to make local optimizations, where we do not need to take care of control flow.

This is not sufficient for all optimizations !

- Global Dead Code Elimination
- Constant Folding
- Loop optimizations
- ...
- **Register allocation**

## Global optimization in practice

Let's optimize this function:

```
int f(int a, int b) {  
    x=a+b;  
    y=a*b;  
    while(y*y>a+b) {  
        a=a+a;  
        x=a+b;  
    }  
    return x;  
}
```

- ### 3 Global optimizations
- Introduction to register allocation
  - Analysis for optimizations : Liveness

## What for?

- Finding storage locations to the values manipulated by the program ▶ registers or memory.
  - registers are fast but in small quantity.
  - memory is plenty, but slower access time.
- ▶ A good register allocator should strive to keep in registers the variables used more often.

"Because of the central role that register allocation plays, both in speeding up the code and in making other optimizations useful, it is one of the most important - if not the most important - of the optimizations."



Hennessy and Patterson (2006) - [Appendix B; p. 26]

# What for?

Expected behavior of **register allocation**:

- Input: a CFG with basic blocks with 3-address code (and pseudo-registers, aka temporaries)
- Output: same CFG but without pseudo-registers:
  - replace with physical registers as much as possible.
  - if not **spill**, ie allocate a place in memory.
  - use the same physical register (or memory location) for as many temporaries as possible.
  - all copies assigned to the same physical registers (“moves”) can be removed: **coalescing (optional)**.

# The key notion: liveness

## Observation

Two variables that are simultaneously **alive** must be assigned different registers.

(formal definition of alive follows)

# Register assignment is NP-complete

## Theorem

Given  $P$  and  $K$  general purpose registers, is there an assignment of the variables  $P$  in registers, such that (i) every variable gets at least one register along its entire live range, and (ii) simultaneously live variables are given different registers ?

Gregory Chaitin has shown, in the early 80's, that the register assignment problem is NP-Complete (register allocation via coloring, 1981)

- 3 Global optimizations
  - Introduction to register allocation
  - Analysis for optimizations : Liveness



# Liveness analysis

Previously we called **variable** a pseudo-register or a physical register.

## Definition (Alive Variable)

*In a given program point, a variable is said to be alive if the value she contains may be used in the rest of the execution.*

May: non decidable property ► overapproximation.

**Important remark:** here a block = a statement/program point. We have the same kind of analyses with block=basic block.

## An example for live ranges

### Definition

A variable is **live** at the exit of a block if there exists a path from the block to a use of the variable that does not redefine the variable.

```

x:=2;
y:=4;
x:=1;
if (y>x)
  then z:=y
  else z:=y*y ;
x:=z;
  
```

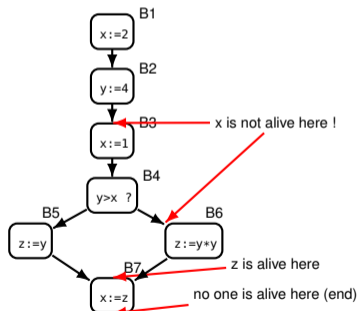

- The information flow is **backward**: from uses to definitions.

## Liveness by hand!

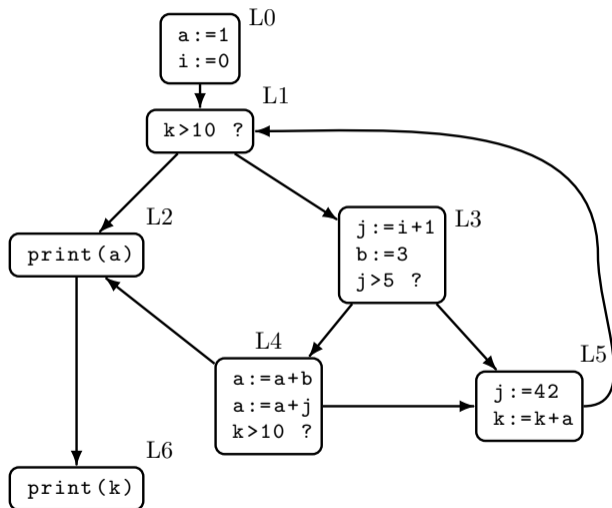

bloc	live variables at bloc exit
L0	
L1	
L2	
L3	
L4	
L5	
L6	$\emptyset$

## Liveness by hand!

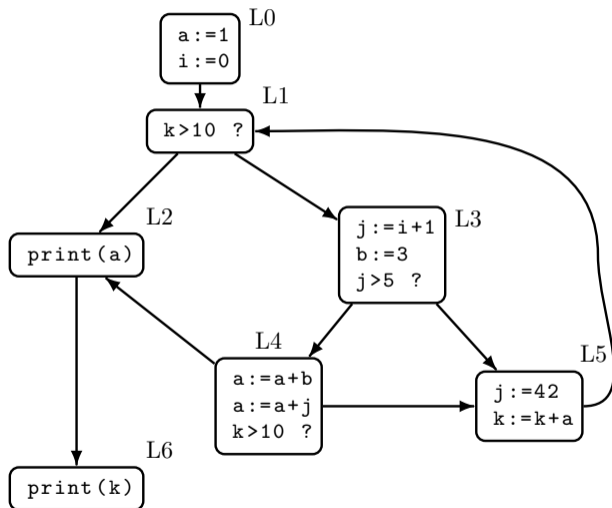

bloc	live variables at bloc exit
L0	a, i, k
L1	a, i, k
L2	k
L3	i, j, a, k, b
L4	a, i, k
L5	a, i, k
L6	$\emptyset$

# How to compute liveness

**Dataflow analysis** is a technique to compute many properties.

- Very versatile
- Expensive in general (fix point on the CFG)
- ▶ Next year in the Static Analysis course!

# Computing liveness: an alternative approach

Instead, we will use an alternative CFG representation that makes it easy to compute liveness and do program transformations! ▶ Next lesson: The **Single Static Assignment** representation

# Summary

- 1 Control flow Graph
- 2 Local optimizations
  - Basic Blocks DAG Construction
  - Instruction Selection
  - Instruction Scheduling
- 3 Global optimizations
  - Introduction to register allocation
  - Analysis for optimizations : Liveness